

**Pixter**  
Multi-Media



**Fisher-Price**

**Owner's Manual**

Model Number: H4651

# Pixter® Multi-Media System

## Software Cartridge

Software cartridge not included  
(sold separately and subject to availability).

## Cartridge Adapter

For use with any Pixter® black and white software cartridge (sold separately). Insert the adapter into the software port. Then, fit the black and white cartridge into the adapter.

## Software Port

Insert a software cartridge (sold separately) into this socket.

## D-pad

Use to select, browse or move objects in gaming activities.

## Speaker

## Lighted Toolbar

You can turn off light to conserve battery power.

## Stylus Storage

## Stylus

## A/B Function Buttons

Use to make selections.

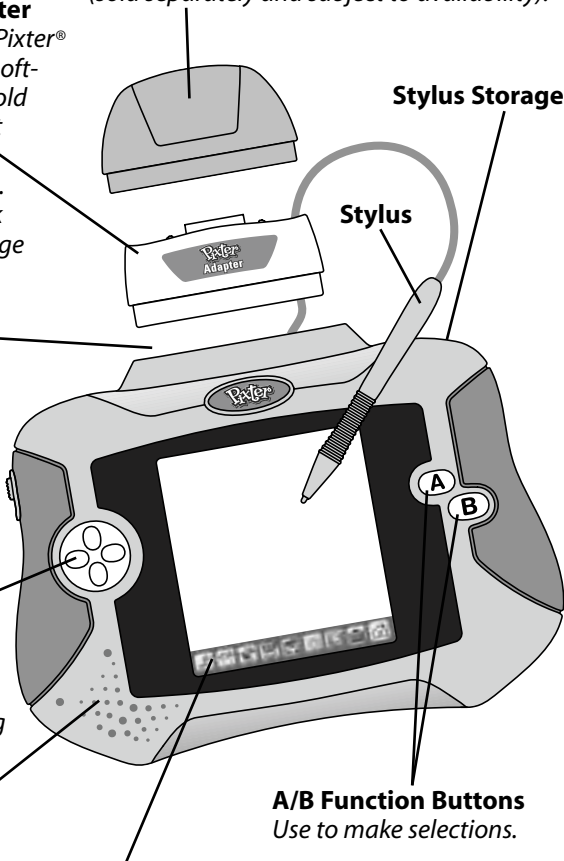

# Pixter® Multi-Media System

## Volume Dial

*Adjust volume to a comfortable listening level.*

## High-Performance TFT Touch Screen

## Power/Light Switch

*Slide the power switch to turn power: on with no light = ; on with light — ; or off ○. When not in use, this product turns off after about three minutes.*

## Calibration

*(on back of product)  
You must calibrate the stylus and screen before first-time use.*

## Headphone Jack

*Use your own headphones (not included) for private listening.*

**Hint:** Pixter® Multi-Media is equipped with a headphone jack for private listening. Be sure your headphones (not included) are equipped with a 3.5 mm pin.

# Before you begin, take note!

- Please keep this manual for future reference, as it contains important information.
- Adult assembly is required to install batteries.
- Tool needed for battery installation: Phillips screwdriver (not included).
- Requires four “AA” (LR6) **alkaline** batteries for operation (not included).
- **Replace batteries when:**
  - Display on the screen becomes difficult to see.
  - Toy functions erratically.
  - Sounds become faint or there are no sounds at all.
- **Use only** the drawing stylus on the screen. **Never** use any other object, such as a regular pen or pencil, on the screen. Markings from regular pens or pencils cannot be removed and will damage the screen.
- Use the cartridge adaptor with any Pixter® black and white software cartridge (sold separately). Note that the display **will still be black and white only!**
- Be sure to turn Pixter® power off before inserting a software cartridge (sold separately) into the software port. Turn Pixter® power back on to play!
- If Pixter® seems to be operating erratically (and you have recently changed the batteries), you may need to reset it. Open the battery compartment door on the back of the unit. Remove and replace the batteries. Replace the battery compartment door.

# Before you begin, take note!

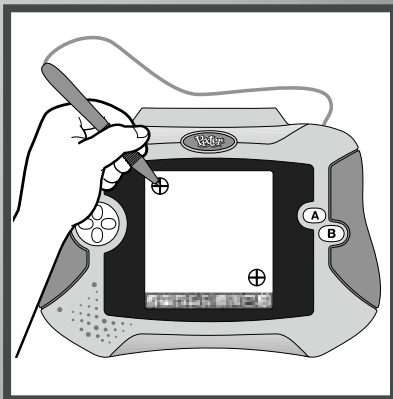
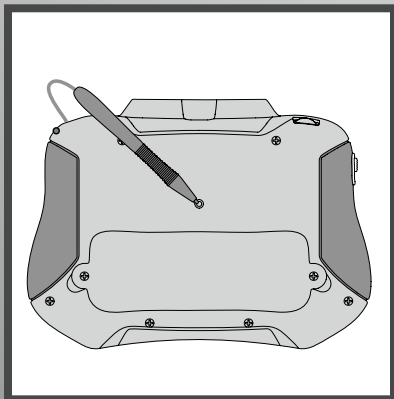

## **IMPORTANT! You must calibrate the stylus to the screen before first-time use.**

- Install four "AA" **alkaline** batteries. Turn Pixter® power on. Wait until you see the Home Screen.
- Turn Pixter® over and locate the calibration hole.
- Insert, push and hold the stylus in the calibration hole. Turn Pixter® over so that you can see the screen. When you see two plus signs ⊕ remove the stylus from the calibration hole.
- First touch the upper left corner ⊕ with the tip of the stylus.
- Then, touch the lower right corner ⊕ with the tip of the stylus.

# The Power of Creativity

Choose a fun activity or game from the Home Screen.  
Use the stylus on the screen.

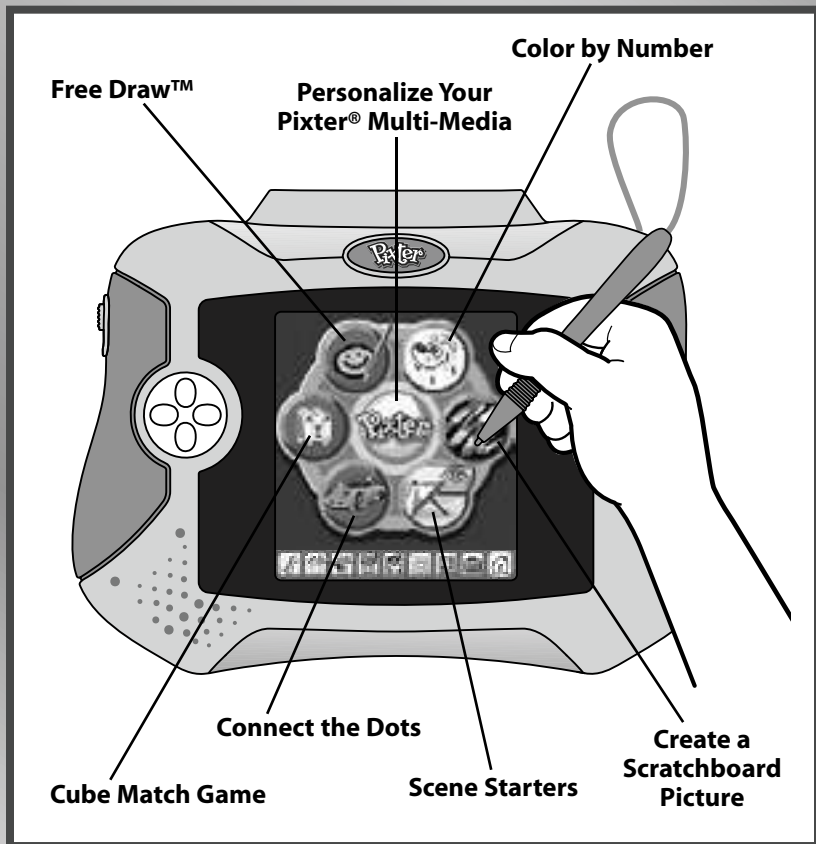

# Awesome Activities and Games!

## Free Draw™





- Use any of the creative tools on the toolbar:

Line Tool 

Shape or Straight Line Maker 

Paint Bucket 

Stamp It! 

Special Effects 

Utilities 

## Color by Number



- Touch the arrows on the bottom of the screen with the stylus (or use the D-pad) to scroll through picture choices.
- When you find one that you like, touch the screen with the stylus (or press the A/B button).
- Touch the paint bucket  in the lower left corner.
- Choose a number/color with the stylus.
- Now, find the number block on the picture. Touch it with the stylus to fill it with color.

# Awesome Activities and Games!

## Create a Scratchboard Picture



- Touch the arrows on the bottom of the screen with the stylus (or use the D-pad) to scroll through picture choices.
- When you find a picture that you like, touch the screen with the stylus (or press the A/B button).
- Now, use the stylus to "scratch" through the black layer to reveal a picture!

## Connect the Dots



- Touch the arrows on the bottom of the screen with the stylus (or use the D-pad) to scroll through each pattern. Can you guess what it will be?
- When you find a pattern that you like, touch the screen with the stylus (or press the A/B button).
- Touch the flashing dot on the screen with the stylus again and again.
- Look at the picture on the screen!



# Awesome Activities and Games!

## Scene Starters

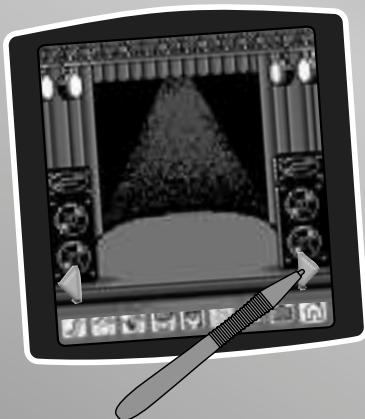

- Touch the arrows on the bottom of the screen with the stylus (or use the D-pad) to scroll through choices.
- When you find a scene that you like, touch the screen with the stylus (or press the A/B button).
- Use any of the creative tools on the toolbar to finish the scene!

### 3-D Effect

- If you'd like to use the 3-D effect, touch the arrows on the bottom of the screen with the stylus (or use the D-pad) to scroll to the last scene. Touch the screen with the stylus (or press the A/B button to select the 3-D scene).
- Look at the 3-D scene! Touch the screen with the stylus (or press the A/B button) to select an angle.
- Now, touch the Stamp It  tool on the toolbar.
- Scroll to the 3-D stamper choices - rocket, astronaut or shooting star. Touch the screen with the stylus (or press the A/B button) to select the stamper.
- Now, use the stylus to place the 3-D stamper in the scene! Use the D-pad to turn the stamper!

# Awesome Activities and Games!

## Cube Match Game

**Object of the game:**

*Match a group of three or more cubes to score points.*

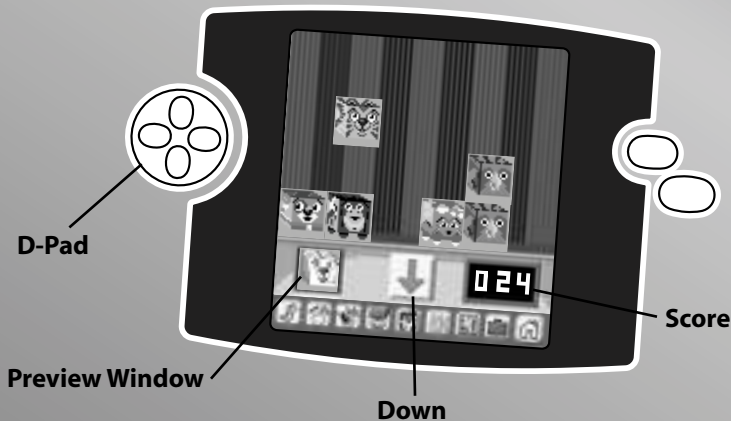

- Watch the cubes drop on the screen. Use the D-pad to move the cubes for matching.

### **Hints:**

- Touch the down arrow on the screen with the stylus to move a cube down quickly.
- Look at the preview window to see the next cube.

**Good job!** You score two points for each cube matched.

# Personalize Your Pixter<sup>®</sup> Multi-Media

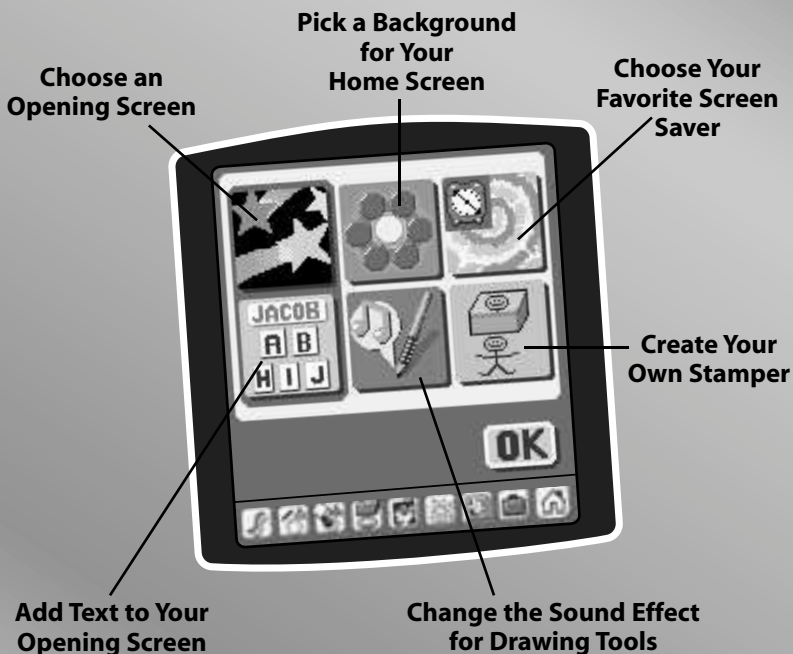

# Personalize Your Pixter<sup>®</sup> Multi-Media

## Choose an Opening Screen

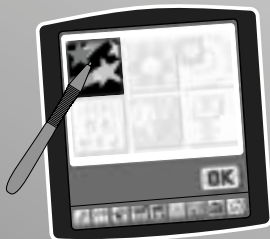

- Choose from three opening screen choices. Touch again and again with the stylus to see choices.
- Now, touch **OK** on the screen with the stylus to make a selection.

## Pick a Background for Your Home Screen



- Choose from six background choices. Touch again and again with the stylus to see choices.
- Now, touch **OK** on the screen with the stylus to make a selection.

## Pick your Favorite Screen Saver



- Choose from three screen saver choices. Touch again and again with the stylus to see choices.
- Now, touch **OK** on the screen with the stylus to make a selection.

## Change the Sound Effect for Drawing Tools



- Touch with the stylus and listen to the sound effect.
- Touch the button again to hear another sound.
- When you find one that you like, touch **OK** on the screen with the stylus.

# Personalize Your Pixter<sup>®</sup> Multi-Media

## Add Text to Your Opening Screen



- Touch the Add Text to Your Opening Screen button on the screen with the stylus.



- Think of a caption or type your name for the opening screen. Now, touch each letter with the stylus. Touch **OK** on the screen with the stylus.
- Touch the screen again with the stylus to place the caption or name on the opening screen.

**Hint:** Choose the regular alphabet or numbers and additional characters for foreign languages.

# Personalize Your Pixter® Multi-Media

## Create Your Own Stamper



- Touch the Create Your Own Stamper button on the screen with the stylus.



- Use any tool on the toolbar to create your stamper design.

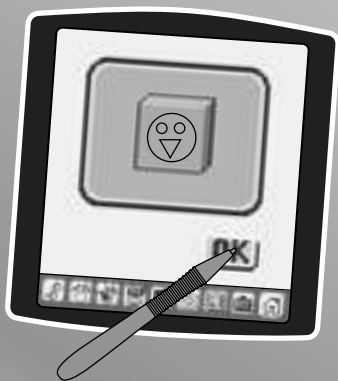

- When you have finished your stamper design, touch **OK** on the screen with the stylus. You have saved your stamper design.

**Hint:** Go to the Stamp It tool on the toolbar to scroll through choices and see your stamper!

# Toolbar

After you choose an activity from the Home Screen, choose a tool!  
Touch the tool with the stylus.



## Line Tool



Touch for freestyle drawing or writing.

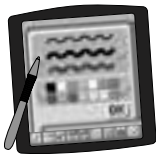

- Touch the upper arrows to choose the type of marking. Choose ; ; ; ; ; ; or .
- Touch the lower arrows on the color palette to choose a color for the line tool.
- Touch **OK** to save your choices!



Create your own drawing or write a message with the stylus.















# Toolbar

## Shape or Straight Line Maker



Touch to make shapes or straight lines



- Touch the upper arrows to choose a shape or line. Choose     ;     ;    ;  or  .
- Touch the lower arrows on the color palette to choose a color for your shape or line.
- Touch  to save your choices!



Touch the screen and drag the stylus to make small or large shapes and lines.

**Hint:** To make a triangle, touch the screen and drag the stylus to make the base of the triangle. Then, touch the base line with the stylus and drag it to complete the triangle.

## Paint Bucket



Touch to choose a color or pattern.



To fill in a selected drawing area, touch the area with the stylus. Watch it fill with color!



# Toolbar

## Stamp It!



Touch for stamper art.

---



Touch the arrows on the bottom of the screen with the stylus (or use the D-pad) to scroll through stamper designs.

---



Touch the screen with the stylus (or press the A/B button) to choose a stamper.

---



Touch the screen as many times as you like with the stylus for lots of stamper fun!

# Toolbar

## Eraser



Touch to make your stylus an eraser or undo the last action.



Choose eraser  or undo .



If you chose eraser  use your stylus to erase any part of what's on the screen.



If you chose undo , whatever you have done last to your picture is gone!

# Toolbar

## Full Screen Erase



Touch to choose an animated full screen erase with cool sound effects.

---



Touch the screen with the stylus to choose the effect.

---



Touch the screen with the stylus and watch and listen as your picture disappears.

**Hint:** After using the full screen erase, you're still in the same activity using the tool you used before you erased the screen.

# Toolbar

## Special Effects



Touch to choose a special effect.



Choose an effect: Confetti, Rotator, Color Surprise or Wind.



### Confetti

Touch  with the stylus. Your picture is all mixed -up! Choose the confetti tool again to mix-up your picture in smaller pieces.



### Rotator

Touch  with the stylus. Look, your picture "turned"!



### Color Surprise

Touch  with the stylus. Surprise, your picture is different!



### Wind

Touch  with the stylus. Your picture looks wind-blown.

# Toolbar



## Utilities



Touch to save or retrieve your drawing; or use Typewriter, Calculator or Stop Watch.



### Save or Retrieve



Touch **IN** file  to save; touch **OUT** file  to retrieve.

#### Hints:

- You can save one picture at a time! Each time you save a picture, it replaces the one already there.
- After you save a picture, it will appear on your screen again. To make a new drawing, choose another activity/tool.





### Typewriter

Touch  with the stylus. To create your own caption, touch each letter of each word. Touch  to save your caption. Touch the screen to stamp it.







### Calculator

Touch  with the stylus. Touch the number key and function keys with the stylus. Touch  to go back to your activity.



### Stop Watch

Touch  with the stylus. Touch  with the stylus to start the clock; touch  with the stylus to stop the clock; touch  with the stylus to reset the clock. Touch  to go back to your activity.

# Toolbar

## Home



Touch to go back to the Home Screen



Choose an activity or game: Free Draw™, Color by Number, Create a Scratchboard Picture, Scene Starters, Connect the Dots, or Cube Match Game.



# Calibrating the Stylus

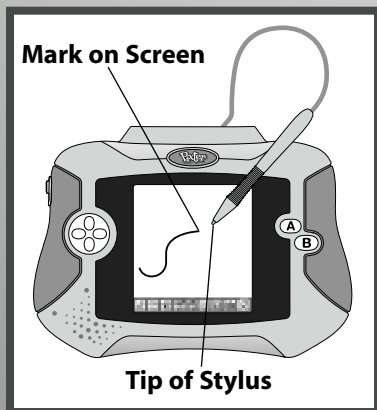

## IMPORTANT!

From time to time, the mark made on your screen from the stylus and the location of the tip of the stylus may not align. When this happens, you **must** calibrate the stylus.

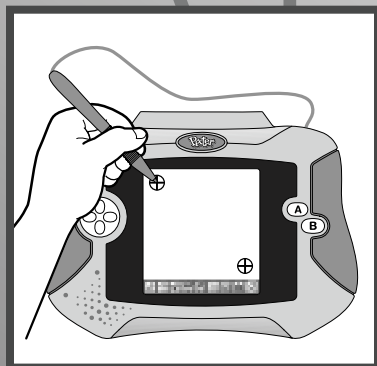
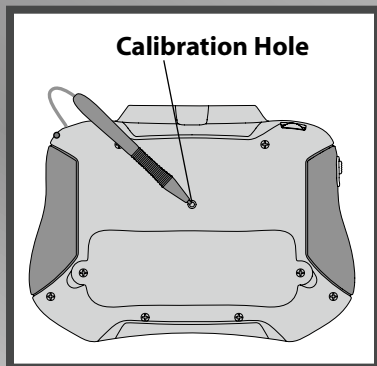

- Turn Pixter® over and locate the calibration hole.
- Insert, push and hold the stylus in the calibration hole. Turn Pixter over so that you can see the screen. When you see two ⊕, you can remove the stylus from the calibration hole.
- First touch the upper left corner ⊕ with the tip of the stylus.
- Then, touch the lower right corner ⊕ with the tip of the stylus.

# Battery Installation

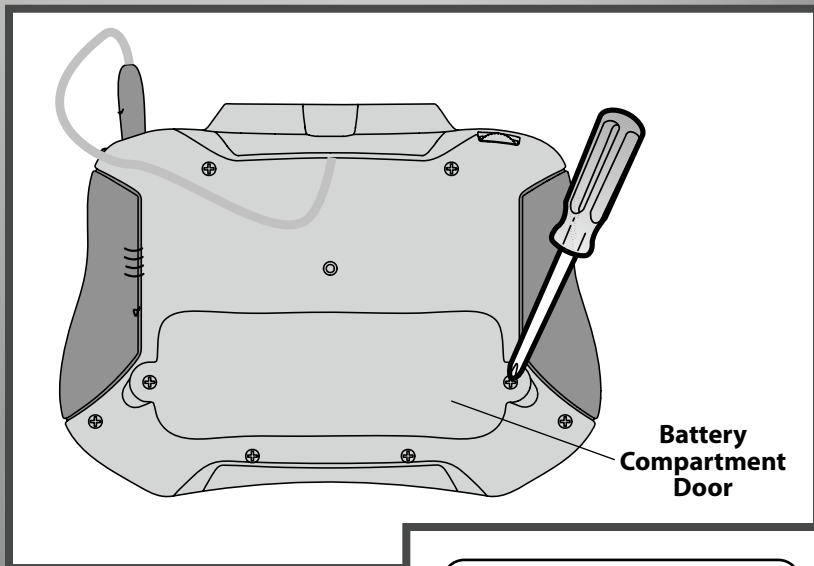

- Locate the battery compartment on the back of the toy.
- Loosen the screw in the battery compartment door with a Phillips screwdriver.
- Lift to remove the battery compartment door.
- Insert four "AA" (LR6) **alkaline** batteries.

**Hint:** We recommend using **alkaline** batteries for longer battery life.

- Replace the battery compartment door and tighten the screw with a Phillips screwdriver. Do not over-tighten.

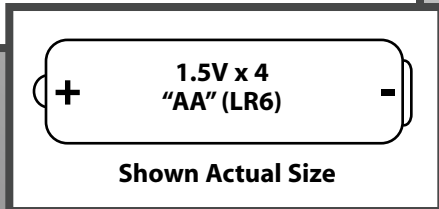



# Battery Safety Information

In exceptional circumstances, batteries may leak fluids that can cause a chemical burn injury or ruin your product. To avoid battery leakage:

- Do not mix old and new batteries or batteries of different types: alkaline, standard (carbon-zinc) or rechargeable (nickel-cadmium).
- Insert batteries as indicated inside the battery compartment.
- Remove batteries during long periods of non-use. Always remove exhausted batteries from the product. Dispose of batteries safely. Do not dispose of batteries in a fire. The batteries may explode or leak.
- Never short-circuit the battery terminals.
- Use only batteries of the same or equivalent type, as recommended.
- Do not charge non-rechargeable batteries.
- Remove rechargeable batteries from the product before charging.
- If removable, rechargeable batteries are used, they are only to be charged under adult supervision.



## Care

- Keep water, sand and dirt off of this product.
- Keep this product away from direct sunlight and excessive heat.
- Wipe this product with a clean cloth dampened with a mild soap and water solution. Do not immerse this product.
- This toy has no consumer serviceable parts. Please do not take this product apart.
- Do not drop this product on a hard surface.

# FCC Statement (United States Only)

This equipment has been tested and found to comply with the limits for a Class B digital device, pursuant to part 15 of the FCC rules. These limits are designed to provide reasonable protection against harmful interference in a residential installation. This equipment generates, uses and can radiate radio frequency energy and, if not installed and used in accordance with the instructions, may cause harmful interference to radio communications. However, there is no guarantee that interference will not occur in a particular installation. If this equipment does cause harmful interference to radio or television reception, which can be determined by turning the equipment off and on, the user is encouraged to try to correct the interference by one or more of the following measures:

- Reorient or relocate the receiving antenna.
- Increase the separation between the equipment and receiver.
- Consult the dealer or an experienced radio/TV technician for help.

Note: Changes or modifications not expressly approved by the manufacturer responsible for compliance could void the user's authority to operate the equipment.



# One (1) Year Limited Warranty

Fisher-Price, Inc., 636 Girard Avenue, East Aurora, New York 14052  
warrants Pixter® Multi-Media is free from all defects in material and workmanship when used under normal conditions for a period of one (1) year from the date of purchase.

Should the product fail to perform properly, we will repair or replace it at our option, free of charge. Purchaser is responsible for shipping the product to Consumer Relations at the address indicated above and for all associated freight and insurance cost. Fisher-Price, Inc. will bear the cost of shipping the repaired or replaced item to you.

**THIS WARRANTY IS VOID IF THE OWNER REPAIRS OR MODIFIES THE PRODUCT. THIS WARRANTY EXCLUDES ANY LIABILITY OTHER THAN THAT EXPRESSLY STATED ABOVE INCLUDING BUT NOT LIMITED TO ANY INCIDENTAL OR CONSEQUENTIAL DAMAGES.**

**SOME STATES DO NOT ALLOW THE EXCLUSION OR LIMITATION OF INCIDENTAL OR CONSEQUENTIAL DAMAGES, SO THE ABOVE LIMITATION OR EXCLUSION MAY NOT APPLY TO YOU.**

**THIS WARRANTY GIVES YOU SPECIFIC LEGAL RIGHTS, AND YOU MAY ALSO HAVE OTHER RIGHTS WHICH MAY VARY FROM STATE TO STATE.**

# Consumer Information

Visit us on-line at [www.service.fisher-price.com](http://www.service.fisher-price.com).

Call Fisher-Price® Consumer Relations, toll-free at **1-800-432-5437**, 8 AM- 6 PM EST Monday through Friday. Hearing-impaired consumers using TTY/TDD equipment, please call 1-800-382-7470.

Write to:

Fisher-Price®  
Consumer Relations  
636 Girard Avenue  
East Aurora, New York 14052

For countries outside the United States:

## **CANADA**

**Questions? 1-800-567-7724**, Mattel Canada Inc., 6155 Freemont Blvd., Mississauga, Ontario L5R 3W2; [www.service.mattel.com](http://www.service.mattel.com).

## **GREAT BRITAIN**

Mattel UK Ltd, Vanwall Business Park, Maidenhead SL6 4UB. Helpline: 01628 500303:  
[www.service.mattel.com/uk](http://www.service.mattel.com/uk).

## **AUSTRALIA**

Mattel Australia Pty. Ltd., 658 Church Street, Locked Bag #870, Richmond, Victoria 3121 Australia. Consumer Advisory Service 1300 135 312.

## **NEW ZEALAND**

16-18 William Pickering Drive, Albany 1331, Auckland.

## **ASIA**

Mattel East Asia Ltd, Room 1106, South Tower, World Finance Centre, Harbour City, Tsimshatsui, HK, China.

Fisher-Price, Inc., a subsidiary of Mattel, Inc., East Aurora, NY 14052 U.S.A.  
©2005 Mattel, Inc. All Right Reserved. © and ™ designate  
U.S. trademarks of Mattel, Inc.